

ORIHOMEDICAL

G m b H · I M P L A N T S



**Titanium Femoral and
Tibial Nailing System**

Titanium Femoral Nail

Antegrade Indication

- Pertrochanteric fractures
- Intertrochanteric fractures
- High subtrochanteric fractures
- Low subtrochanteric fractures
- Distal shaft fractures

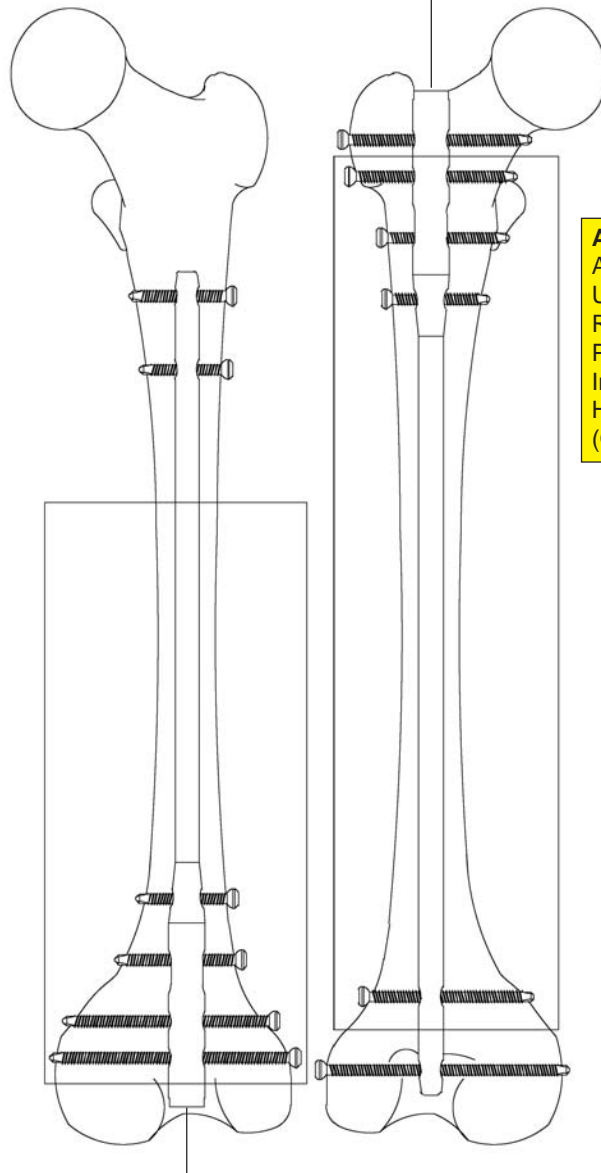

Advantages:

- Ante- and retrograde Indication
- Unreamed insertion
- Rotation stability
- Proximal angle stability
- Intra- and postoperative security insertion
- High economy
- (One nail for left and right)

Retrograde Indication

- Shaft fractures
- Distal shaft fractures
- Condylar fractures

Product Description for $\varnothing 8.0 / \varnothing 9.0$ mm Titanium - U/R Solid Femoral Nails

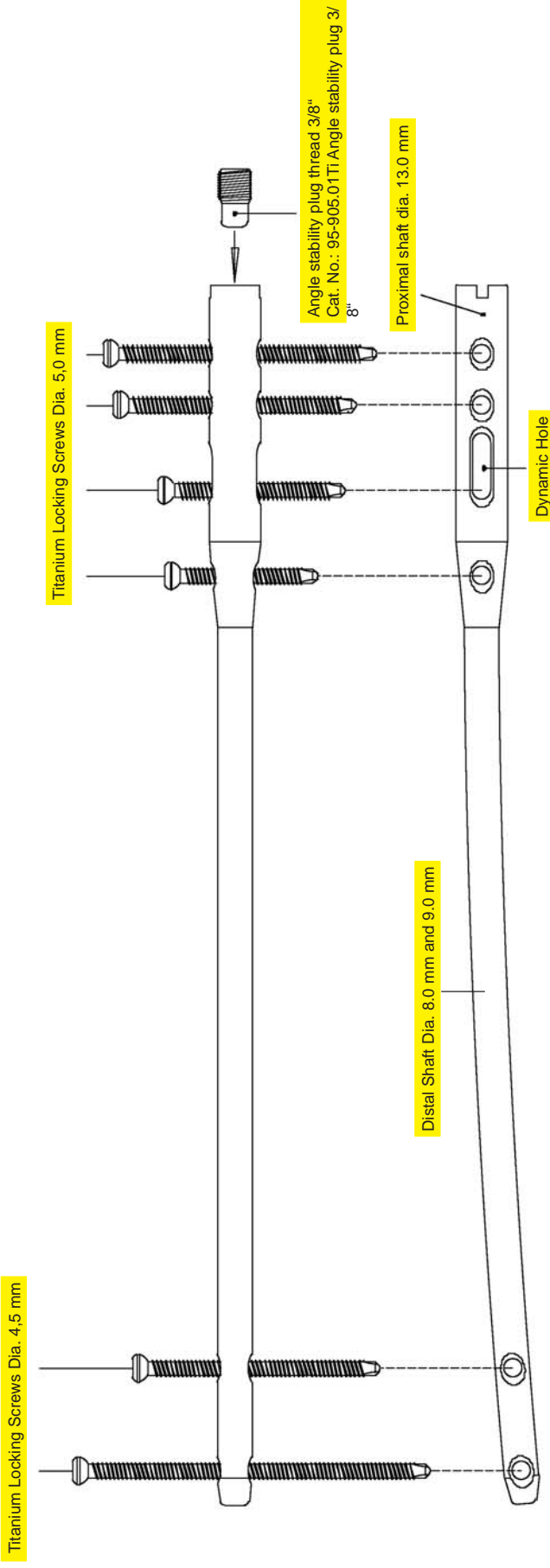

Titanium Locking Screw Implants Dia. 4.5 mm		Titanium Locking Screw Implants Dia. 5.0 mm		Titanium Solid Femoral Nail Implants Dia. 8.0 mm		Titanium Solid Femoral Nail Implants Dia. 9.0 mm	
Cat. No.	Dia.	Length	Dia.	Length	Dia.	Length	Dia.
95-910.25Ti	$\varnothing 4.5$ mm	25 mm	$\varnothing 5.0$ mm	25 mm	$\varnothing 8.0$ mm	280 mm	$\varnothing 9.0$ mm
95-910.30Ti	$\varnothing 4.5$ mm	30 mm	$\varnothing 5.0$ mm	30 mm	$\varnothing 8.0$ mm	300 mm	$\varnothing 9.0$ mm
95-910.35Ti	$\varnothing 4.5$ mm	35 mm	$\varnothing 5.0$ mm	35 mm	$\varnothing 8.0$ mm	320 mm	$\varnothing 9.0$ mm
95-910.40Ti	$\varnothing 4.5$ mm	40 mm	$\varnothing 5.0$ mm	40 mm	$\varnothing 8.0$ mm	340 mm	$\varnothing 9.0$ mm
95-910.45Ti	$\varnothing 4.5$ mm	45 mm	$\varnothing 5.0$ mm	45 mm	$\varnothing 8.0$ mm	360 mm	$\varnothing 9.0$ mm
95-910.50Ti	$\varnothing 4.5$ mm	50 mm	$\varnothing 5.0$ mm	50 mm	$\varnothing 8.0$ mm	380 mm	$\varnothing 9.0$ mm
95-910.55Ti	$\varnothing 4.5$ mm	55 mm	$\varnothing 5.0$ mm	55 mm	$\varnothing 8.0$ mm	380 mm	$\varnothing 9.0$ mm
95-910.60Ti	$\varnothing 4.5$ mm	60 mm	$\varnothing 5.0$ mm	60 mm			$\varnothing 9.0$ mm
95-910.65Ti	$\varnothing 4.5$ mm	65 mm	$\varnothing 5.0$ mm	65 mm			$\varnothing 9.0$ mm
95-910.70Ti	$\varnothing 4.5$ mm	70 mm	$\varnothing 5.0$ mm	70 mm			$\varnothing 9.0$ mm
95-910.75Ti	$\varnothing 4.5$ mm	75 mm	$\varnothing 5.0$ mm	75 mm			$\varnothing 9.0$ mm
95-910.80Ti	$\varnothing 4.5$ mm	80 mm	$\varnothing 5.0$ mm	80 mm			$\varnothing 9.0$ mm
95-910.85Ti	$\varnothing 4.5$ mm	85 mm	$\varnothing 5.0$ mm	85 mm			$\varnothing 9.0$ mm
95-910.90Ti	$\varnothing 4.5$ mm	90 mm	$\varnothing 5.0$ mm	90 mm			$\varnothing 9.0$ mm
95-910.95Ti	$\varnothing 4.5$ mm	95 mm	$\varnothing 5.0$ mm	95 mm			$\varnothing 9.0$ mm
95-910.100Ti	$\varnothing 4.5$ mm	100 mm	$\varnothing 5.0$ mm	100 mm			$\varnothing 9.0$ mm

Product Description for $\varnothing 8.0 / 9.0$ mm Titanium - U/R Solid Femoral Nails
 Material for Titanium Implants: DIN ISO 5832-3 Titanium Alloy Ti-6Al-4V
 according to biocompatibility DIN ISO 10993-1:2003

Product Description for $\varnothing 10.0 / \varnothing 11.0$ mm Titanium - U/R Cannulated Femoral Nails

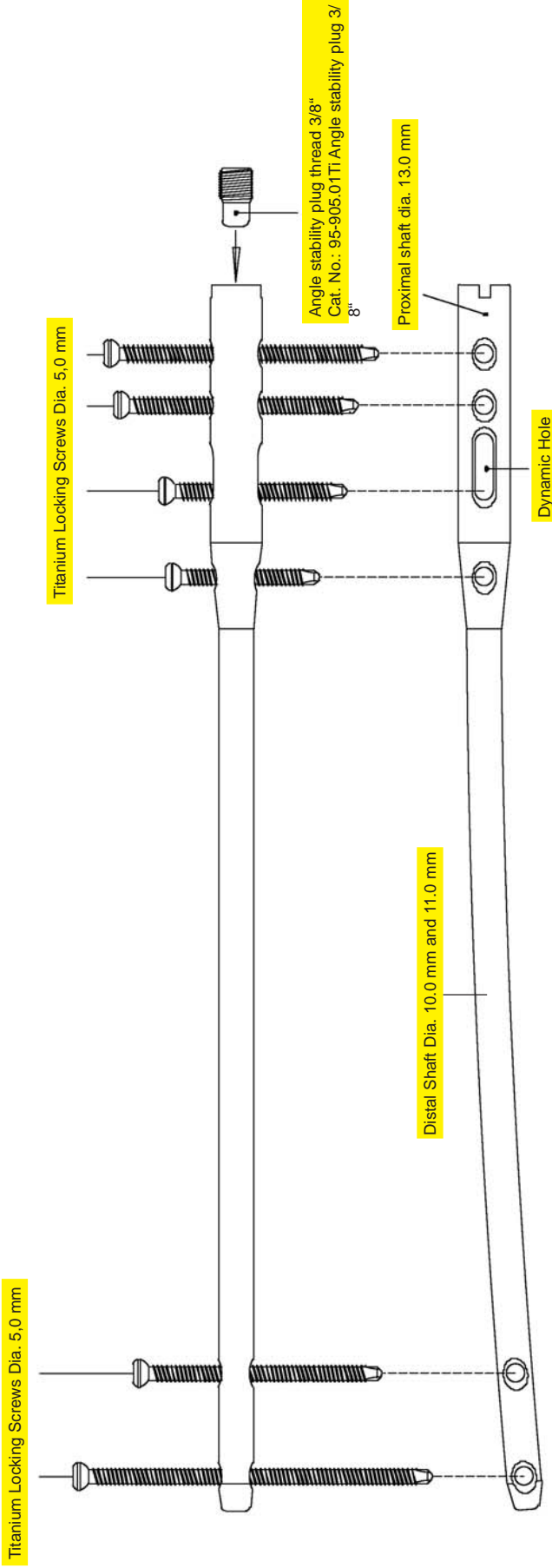

Titanium Locking Screw Implants Dia. 5.0 mm		Titanium Cannulated Femoral Nail Implants Dia. 10.0 mm		Titanium Cannulated Femoral Nail Implants Dia. 11.0 mm			
Cat. No.	Dia.	Length	Dia.	Length	Cat. No.	Dia.	Length
95-911.25Ti	$\varnothing 5.0$ mm	25 mm	$\varnothing 10.0$ mm	300 mm	95-943.30Ti	$\varnothing 11.0$ mm	300 mm
95-911.30Ti	$\varnothing 5.0$ mm	30 mm	$\varnothing 10.0$ mm	320 mm	95-943.32Ti	$\varnothing 11.0$ mm	320 mm
95-911.35Ti	$\varnothing 5.0$ mm	35 mm	$\varnothing 10.0$ mm	340 mm	95-943.34Ti	$\varnothing 11.0$ mm	340 mm
95-911.40Ti	$\varnothing 5.0$ mm	40 mm	$\varnothing 10.0$ mm	360 mm	95-943.36Ti	$\varnothing 11.0$ mm	360 mm
95-911.45Ti	$\varnothing 5.0$ mm	45 mm	$\varnothing 10.0$ mm	380 mm	95-943.38Ti	$\varnothing 11.0$ mm	380 mm
95-911.50Ti	$\varnothing 5.0$ mm	50 mm	$\varnothing 10.0$ mm	400 mm	95-943.40Ti	$\varnothing 11.0$ mm	400 mm
95-911.55Ti	$\varnothing 5.0$ mm	55 mm	$\varnothing 10.0$ mm	420 mm	95-943.42Ti	$\varnothing 11.0$ mm	420 mm
95-911.60Ti	$\varnothing 5.0$ mm	60 mm	$\varnothing 10.0$ mm	440 mm	95-943.44Ti	$\varnothing 11.0$ mm	440 mm
95-911.65Ti	$\varnothing 5.0$ mm	65 mm	$\varnothing 10.0$ mm	460 mm	95-943.46Ti	$\varnothing 11.0$ mm	460 mm
95-911.70Ti	$\varnothing 5.0$ mm	70 mm	$\varnothing 10.0$ mm	480 mm	95-943.48Ti	$\varnothing 11.0$ mm	480 mm
95-911.75Ti	$\varnothing 5.0$ mm	75 mm	$\varnothing 10.0$ mm		95-943.50Ti	$\varnothing 11.0$ mm	500 mm
95-911.80Ti	$\varnothing 5.0$ mm	80 mm					
95-911.85Ti	$\varnothing 5.0$ mm	85 mm					
95-911.90Ti	$\varnothing 5.0$ mm	90 mm					
95-911.95Ti	$\varnothing 5.0$ mm	95 mm					
95-911.100Ti	$\varnothing 5.0$ mm	100 mm					

Product Description for $\varnothing 10.0 / \varnothing 11.0$ mm Titanium - U/R Cannulated Femoral Nails
 Material for Titanium Implants: DIN ISO 5832-3 Titanium Alloy Ti-6Al-4V
 according to biocompatibility DIN ISO 10993-1:2003

Titanium Tibial Nail

Indication

- Proximal fractures
- Shaft fractures
- Distal shaft fractures

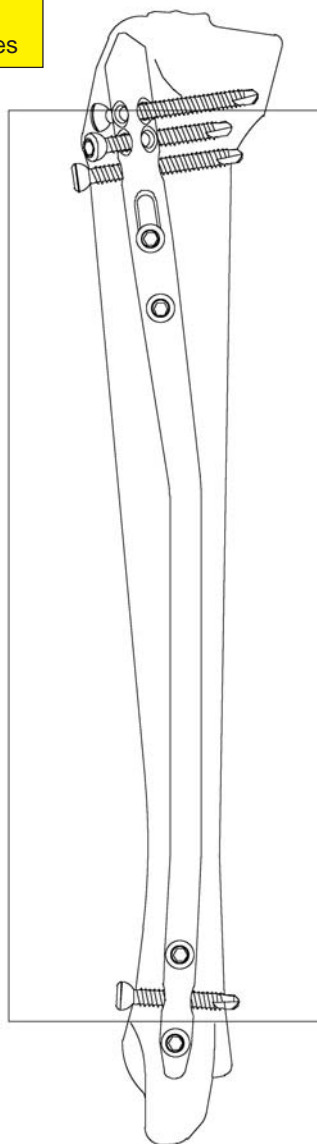

Advantages:

- Unreamed insertion
- Rotation stability
- Proximal angle stability
- Intra- and postoperative security insertion
- Dynamisation
- High economy

Product Description for $\varnothing 8.0 / \varnothing 9.0$ mm Titanium - U/R Solid Tibial Nails

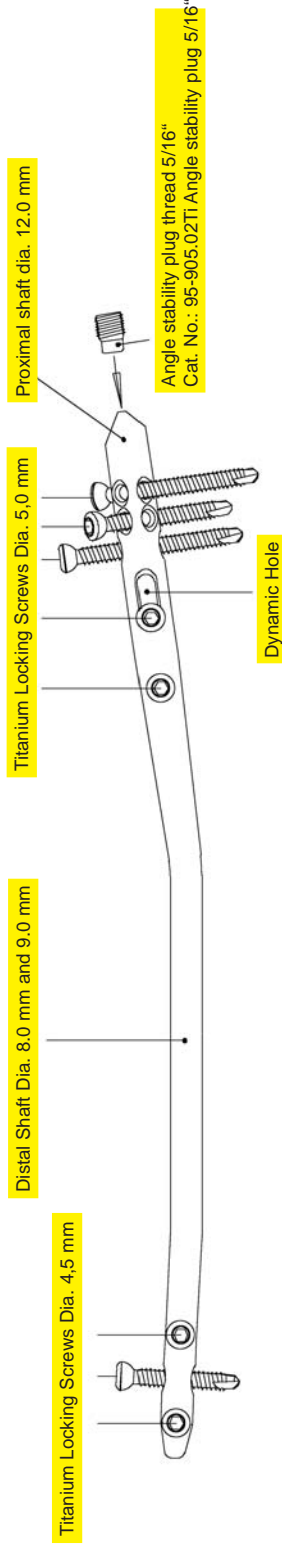

Titanium Locking Screw Implants Dia. 4.5 mm			Titanium Locking Screw Implants Dia. 5.0 mm			Titanium Solid Tibial Nail Implants Dia. 8.0 mm			Titanium Solid Tibial Nail Implants Dia. 9.0 mm		
Cat. No.	Dia.	Length	Cat. No.	Dia.	Length	Cat. No.	Dia.	Length	Cat. No.	Dia.	Length
95-910.25Ti	$\varnothing 4.5$ mm	25 mm	95-911.25Ti	$\varnothing 5.0$ mm	25 mm	95-950.25Ti	$\varnothing 8.0$ mm	255 mm	95-951.25Ti	$\varnothing 9.0$ mm	255 mm
95-910.30Ti	$\varnothing 4.5$ mm	30 mm	95-911.30Ti	$\varnothing 5.0$ mm	30 mm	95-950.27Ti	$\varnothing 8.0$ mm	270 mm	95-951.27Ti	$\varnothing 9.0$ mm	270 mm
95-910.35Ti	$\varnothing 4.5$ mm	35 mm	95-911.35Ti	$\varnothing 5.0$ mm	35 mm	95-950.28Ti	$\varnothing 8.0$ mm	285 mm	95-951.28Ti	$\varnothing 9.0$ mm	285 mm
95-910.40Ti	$\varnothing 4.5$ mm	40 mm	95-911.40Ti	$\varnothing 5.0$ mm	40 mm	95-950.30Ti	$\varnothing 8.0$ mm	300 mm	95-951.30Ti	$\varnothing 9.0$ mm	300 mm
95-910.45Ti	$\varnothing 4.5$ mm	45 mm	95-911.45Ti	$\varnothing 5.0$ mm	45 mm	95-950.31Ti	$\varnothing 8.0$ mm	315 mm	95-951.31Ti	$\varnothing 9.0$ mm	315 mm
95-910.50Ti	$\varnothing 4.5$ mm	50 mm	95-911.50Ti	$\varnothing 5.0$ mm	50 mm	95-950.33Ti	$\varnothing 8.0$ mm	330 mm	95-951.33Ti	$\varnothing 9.0$ mm	330 mm
95-910.55Ti	$\varnothing 4.5$ mm	55 mm	95-911.55Ti	$\varnothing 5.0$ mm	55 mm	95-950.34Ti	$\varnothing 8.0$ mm	345 mm	95-951.34Ti	$\varnothing 9.0$ mm	345 mm
95-910.60Ti	$\varnothing 4.5$ mm	60 mm	95-911.60Ti	$\varnothing 5.0$ mm	60 mm	95-950.36Ti	$\varnothing 8.0$ mm	360 mm	95-951.36Ti	$\varnothing 9.0$ mm	360 mm
95-910.65Ti	$\varnothing 4.5$ mm	65 mm	95-911.65Ti	$\varnothing 5.0$ mm	65 mm	95-950.38Ti	$\varnothing 8.0$ mm	380 mm	95-951.38Ti	$\varnothing 9.0$ mm	380 mm
95-910.70Ti	$\varnothing 4.5$ mm	70 mm	95-911.70Ti	$\varnothing 5.0$ mm	70 mm				95-951.40Ti	$\varnothing 9.0$ mm	400 mm
95-910.75Ti	$\varnothing 4.5$ mm	75 mm	95-911.75Ti	$\varnothing 5.0$ mm	75 mm				95-951.42Ti	$\varnothing 9.0$ mm	420 mm
95-910.80Ti	$\varnothing 4.5$ mm	80 mm	95-911.80Ti	$\varnothing 5.0$ mm	80 mm						
95-910.85Ti	$\varnothing 4.5$ mm	85 mm	95-911.85Ti	$\varnothing 5.0$ mm	85 mm						
95-910.90Ti	$\varnothing 4.5$ mm	90 mm	95-911.90Ti	$\varnothing 5.0$ mm	90 mm						
95-910.95Ti	$\varnothing 4.5$ mm	95 mm	95-911.95Ti	$\varnothing 5.0$ mm	95 mm						
95-910.100Ti	$\varnothing 4.5$ mm	100 mm	95-911.100Ti	$\varnothing 5.0$ mm	100 mm						

Product Description for $\varnothing 8.0 / 9.0$ mm Titanium - U/R Solid Tibial Nails
 Material for Titanium Implants: DIN ISO 5832-3 Titanium Alloy Ti-6Al-4V
 according to biocompatibility DIN ISO 10993-1:2003

Product Description for \varnothing 10.0 / \varnothing 11.0 mm Titanium - U/R Cannulated Tibial Nails

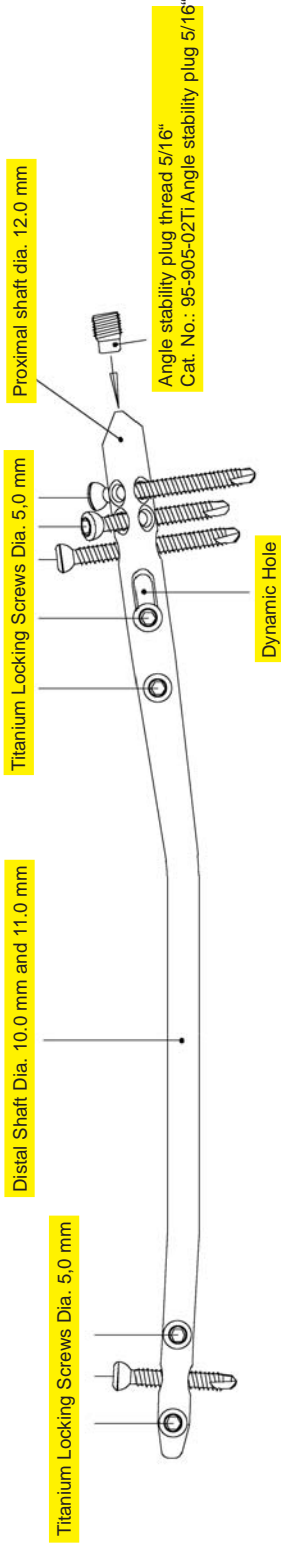

Titanium Locking Screw Implants Dia. 5.0 mm			Titanium Cannulated Tibial Nail Implants Dia. 10.0 mm			Titanium Cannulated Tibial Nail Implants Dia. 11.0 mm		
Cat. No.	Dia.	Length	Cat. No.	Dia.	Length	Cat. No.	Dia.	Length
95-911.25Ti	\varnothing 5.0 mm	25 mm	95-952.25Ti	\varnothing 10.0 mm	255 mm	95-953.25Ti	\varnothing 11.0 mm	255 mm
95-911.30Ti	\varnothing 5.0 mm	30 mm	95-952.27Ti	\varnothing 10.0 mm	270 mm	95-953.27Ti	\varnothing 11.0 mm	270 mm
95-911.35Ti	\varnothing 5.0 mm	35 mm	95-952.28Ti	\varnothing 10.0 mm	285 mm	95-953.28Ti	\varnothing 11.0 mm	285 mm
95-911.40Ti	\varnothing 5.0 mm	40 mm	95-952.30Ti	\varnothing 10.0 mm	300 mm	95-953.30Ti	\varnothing 11.0 mm	300 mm
95-911.45Ti	\varnothing 5.0 mm	45 mm	95-952.31Ti	\varnothing 10.0 mm	315 mm	95-953.31Ti	\varnothing 11.0 mm	315 mm
95-911.50Ti	\varnothing 5.0 mm	50 mm	95-952.33Ti	\varnothing 10.0 mm	330 mm	95-953.33Ti	\varnothing 11.0 mm	330 mm
95-911.55Ti	\varnothing 5.0 mm	55 mm	95-952.34Ti	\varnothing 10.0 mm	345 mm	95-953.34Ti	\varnothing 11.0 mm	345 mm
95-911.60Ti	\varnothing 5.0 mm	60 mm	95-952.36Ti	\varnothing 10.0 mm	360 mm	95-953.36Ti	\varnothing 11.0 mm	360 mm
95-911.65Ti	\varnothing 5.0 mm	65 mm	95-952.38Ti	\varnothing 10.0 mm	380 mm	95-953.38Ti	\varnothing 11.0 mm	380 mm
95-911.70Ti	\varnothing 5.0 mm	70 mm	95-952.40Ti	\varnothing 10.0 mm	400 mm	95-953.40Ti	\varnothing 11.0 mm	400 mm
95-911.75Ti	\varnothing 5.0 mm	75 mm	95-952.42Ti	\varnothing 10.0 mm	420 mm	95-953.42Ti	\varnothing 11.0 mm	420 mm
95-911.80Ti	\varnothing 5.0 mm	80 mm				95-953.44Ti	\varnothing 11.0 mm	440 mm
95-911.85Ti	\varnothing 5.0 mm	85 mm						
95-911.90Ti	\varnothing 5.0 mm	90 mm						
95-911.95Ti	\varnothing 5.0 mm	95 mm						
95-911.100Ti	\varnothing 5.0 mm	100 mm						

Product Description for \varnothing 10.0 / 11.0 mm Titanium - U/R Cannulated Tibial Nails
 Material for Titanium Implants: DIN ISO 5832-3 Titanium Alloy Ti-6Al-4V
 according to biocompatibility DIN ISO 10993-1:2003

Listing: 95-960.00 Titanium Locking Screw and Plug Set (Titanium Screws and Plugs in Mat. DIN ISO 5832-3)

95-960.10 Tray for Titanium Locking Screw and Plug Set (Steel) GRAPHIC CASE

Cat.: No	Dia. 4.5 mm Locking Screws	Pcs.:
95-910.25Ti	Length 25 mm, Titanium	4
95-910.30Ti	Length 30 mm, Titanium	4
95-910.35Ti	Length 35 mm, Titanium	4
95-910.40Ti	Length 40 mm, Titanium	4
95-910.45Ti	Length 45 mm, Titanium	4
95-910.50Ti	Length 50 mm, Titanium	4
95-910.55Ti	Length 55 mm, Titanium	4
95-910.60Ti	Length 60 mm, Titanium	4
95-910.65Ti	Length 65 mm, Titanium	4
95-910.70Ti	Length 70 mm, Titanium	4
95-910.75Ti	Length 75 mm, Titanium	4
95-910.80Ti	Length 80 mm, Titanium	4
95-910.85Ti	Length 85 mm, Titanium	4
95-910.90Ti	Length 90 mm, Titanium	4
95-910.95Ti	Length 95 mm, Titanium	4
95-910.100Ti	Length 100 mm, Titanium	4

Cat.: No	Dia. 5.0 mm Locking Screws	Pcs.:
95-911.25Ti	Length 25 mm, Titanium	4
95-911.30Ti	Length 30 mm, Titanium	4
95-911.35Ti	Length 35 mm, Titanium	4
95-911.40Ti	Length 40 mm, Titanium	4
95-911.45Ti	Length 45 mm, Titanium	4
95-911.50Ti	Length 50 mm, Titanium	4
95-911.55Ti	Length 55 mm, Titanium	4
95-911.60Ti	Length 60 mm, Titanium	4
95-911.65Ti	Length 65 mm, Titanium	4
95-911.70Ti	Length 70 mm, Titanium	4
95-911.75Ti	Length 75 mm, Titanium	4
95-911.80Ti	Length 80 mm, Titanium	4
95-911.85Ti	Length 85 mm, Titanium	4
95-911.90Ti	Length 90 mm, Titanium	4
95-911.95Ti	Length 95 mm, Titanium	4
95-911.100Ti	Length 100 mm, Titanium	4

Cat.: No		Pcs.:
95-905-01Ti	Titanium Femoral Screw Plug 3/18"	4
95-905-02Ti	Titanium Femoral Screw Plug 5/16"	4
95-193.00	Screw Forceps	1



95-960.00 Tray for Titanium Screw and Plug Set



Recommended Sterilization for 95-960.00 (are not included in the Set):
Cat. No.: 95-960.50 Container 310 x 190 x 130 mm, Lid and Bottom perforated

Listing: 95-965.00 Set for proximal Devices Titanium Tibial and Femoral Nail System

95-965.50	Tray for Proximal Devices, Titanium Tibial and Femoral Nail System	1 pcs.
95-965.60	Proximal Device for Titanium U/R Femoral Nails	1 pcs.
95-809.00	Femoral Adapter Bolt	1 pcs.
95-965.70	Proximal Device for Titanium U/R Tibial Nails	1 pcs.

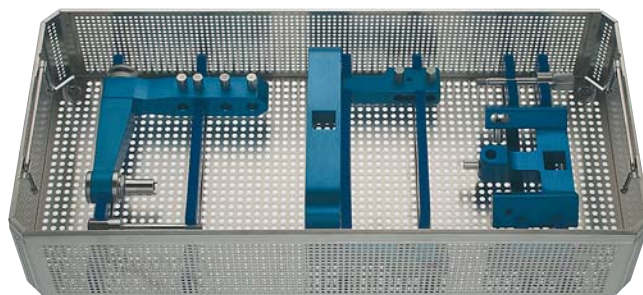
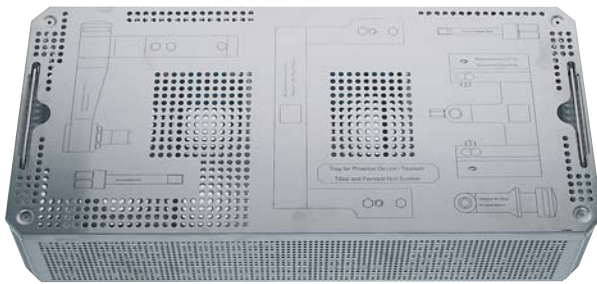

Recommended Sterilization Container for Set 95-965.00
(Are not include in the Set):
Cat. No.: 95-965.10 Sterilization Container

95-965.70 Proximal Device for Titanium U/R Tibial Nails

Assembly components for Tibial proximal Device

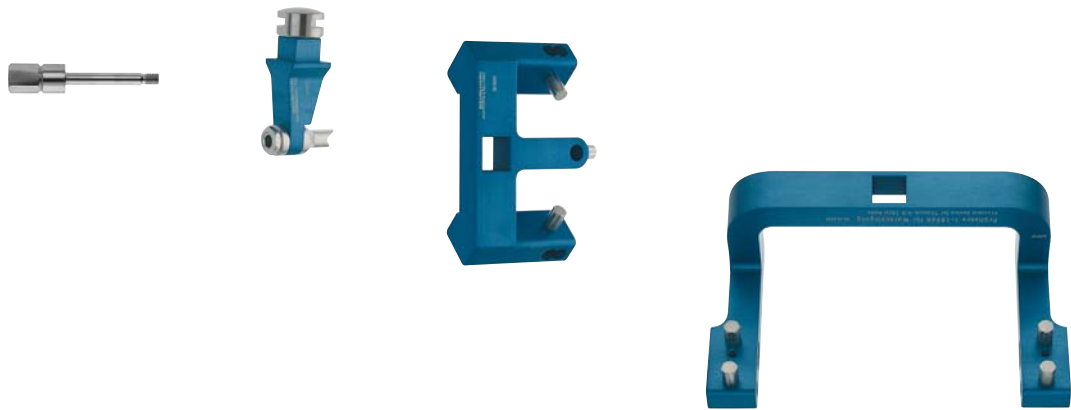

Assembly's

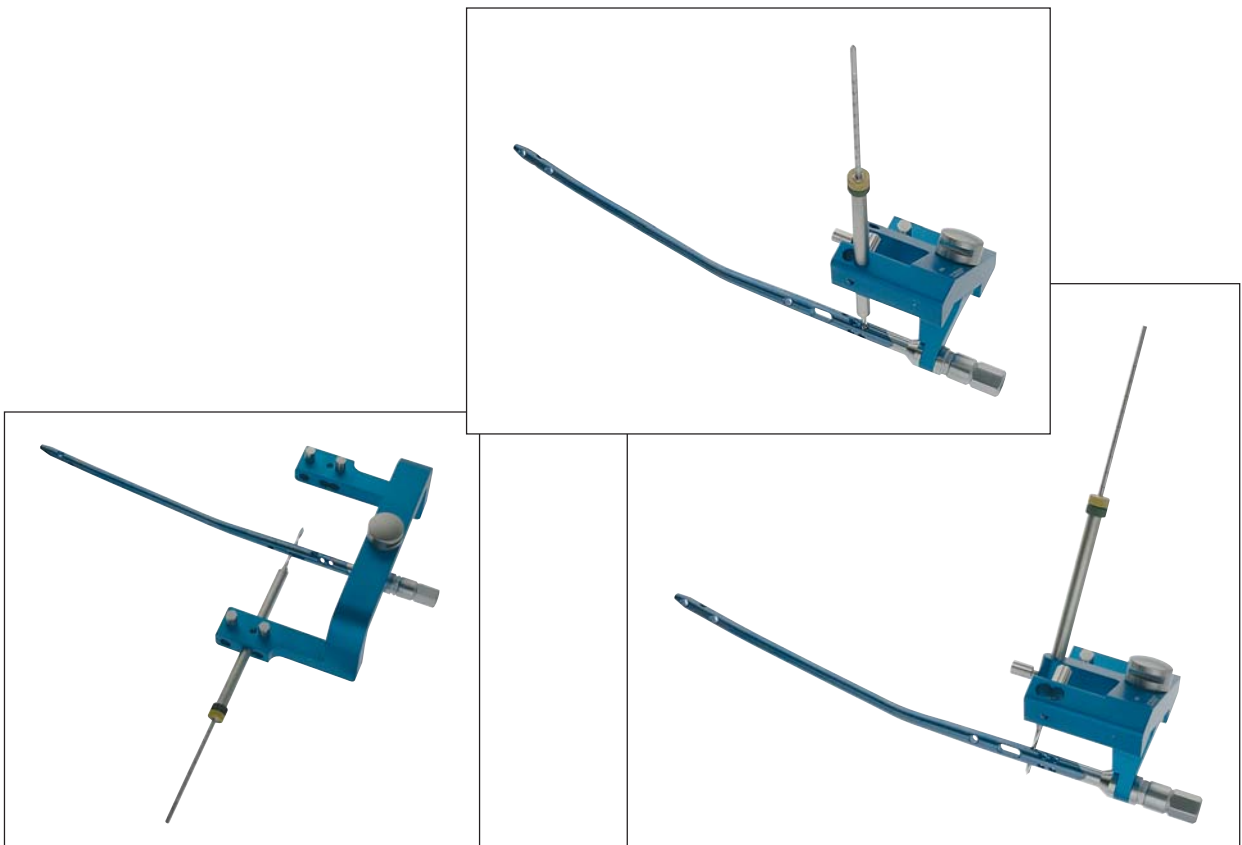

95-965.60 Proximal Device for Titanium U/R Femoral Nails

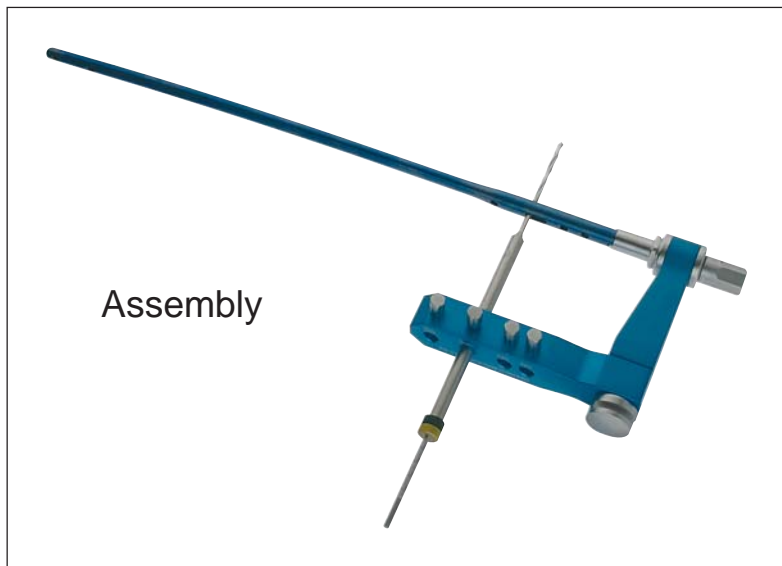
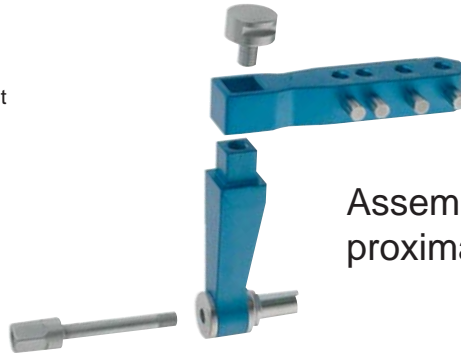
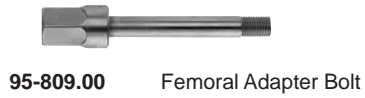

95-965.80 Tibial Adapter Block for Titanium U/R Tibial Nails



95-001.01 Container
Sterilbehälter

95-001.10 Flexible Reamer Set Trays (2 pieces), empty
Siebschalen für flexible Markraumböhrer (nicht gefüllt)



95-037.01 Complete Flexible Medullary Reamer Set
Flexibler Markraumböhrer Satz, komplett

Cat. No.:	Description	Diameter
95-036.02	Flexible Medullary Reamer	6,0 mm
95-036.03	Flexible Medullary Reamer	6,5 mm
95-036.04	Flexible Medullary Reamer	7,0 mm
95-036.05	Flexible Medullary Reamer	7,5 mm
95-036.06	Flexible Medullary Reamer	8,0 mm
95-036.07	Flexible Medullary Reamer	8,5 mm
95-036.08	Flexible Medullary Reamer	9,0 mm
95-036.09	Flexible Medullary Reamer	9,5 mm
95-036.10	Flexible Medullary Reamer	10,0 mm
95-036.11	Flexible Medullary Reamer	10,5 mm
95-036.12	Flexible Medullary Reamer	11,0 mm
95-036.13	Flexible Medullary Reamer	11,5 mm
95-036.14	Flexible Medullary Reamer	12,0 mm
95-036.15	Flexible Medullary Reamer	12,5 mm
95-036.16	Flexible Medullary Reamer	13,0 mm
95-036.17	Flexible Medullary Reamer	13,5 mm
95-036.18	Flexible Medullary Reamer	14,0 mm
95-036.19	Flexible Medullary Reamer	14,5 mm
95-036.20	Flexible Medullary Reamer	15,0 mm
95-036.21	Flexible Medullary Reamer	15,5 mm
95-036.22	Flexible Medullary Reamer	16,0 mm
95-036.23	Flexible Medullary Reamer	16,5 mm
95-036.24	Flexible Medullary Reamer	17,0 mm

Art. Nr.:	Beschreibung	Durchmesser
95-036.02	Flexibler Markraumböhrer	6,0 mm
95-036.03	Flexibler Markraumböhrer	6,5 mm
95-036.04	Flexibler Markraumböhrer	7,0 mm
95-036.05	Flexibler Markraumböhrer	7,5 mm
95-036.06	Flexibler Markraumböhrer	8,0 mm
95-036.07	Flexibler Markraumböhrer	8,5 mm
95-036.08	Flexibler Markraumböhrer	9,0 mm
95-036.09	Flexibler Markraumböhrer	9,5 mm
95-036.10	Flexibler Markraumböhrer	10,0 mm
95-036.11	Flexibler Markraumböhrer	10,5 mm
95-036.12	Flexibler Markraumböhrer	11,0 mm
95-036.13	Flexibler Markraumböhrer	11,5 mm
95-036.14	Flexibler Markraumböhrer	12,0 mm
95-036.15	Flexibler Markraumböhrer	12,5 mm
95-036.16	Flexibler Markraumböhrer	13,0 mm
95-036.17	Flexibler Markraumböhrer	13,5 mm
95-036.18	Flexibler Markraumböhrer	14,0 mm
95-036.19	Flexibler Markraumböhrer	14,5 mm
95-036.20	Flexibler Markraumböhrer	15,0 mm
95-036.21	Flexibler Markraumböhrer	15,5 mm
95-036.22	Flexibler Markraumböhrer	16,0 mm
95-036.23	Flexibler Markraumböhrer	16,5 mm
95-036.24	Flexibler Markraumböhrer	17,0 mm

95-970.00 BASIC INSTRUMENTATION SET FOR INTERLOCKING NAIL SYSTEM
BASIS INSTRUMENTARIUMSATZ FÜR VERRIEGELUNGS-NAGELSYSTEM

95-970.10 Tray - Set for 95-970.00 (3 pieces) Graphic Case
Siebschaleneinsatz für 95-970.00 (3 Stück)

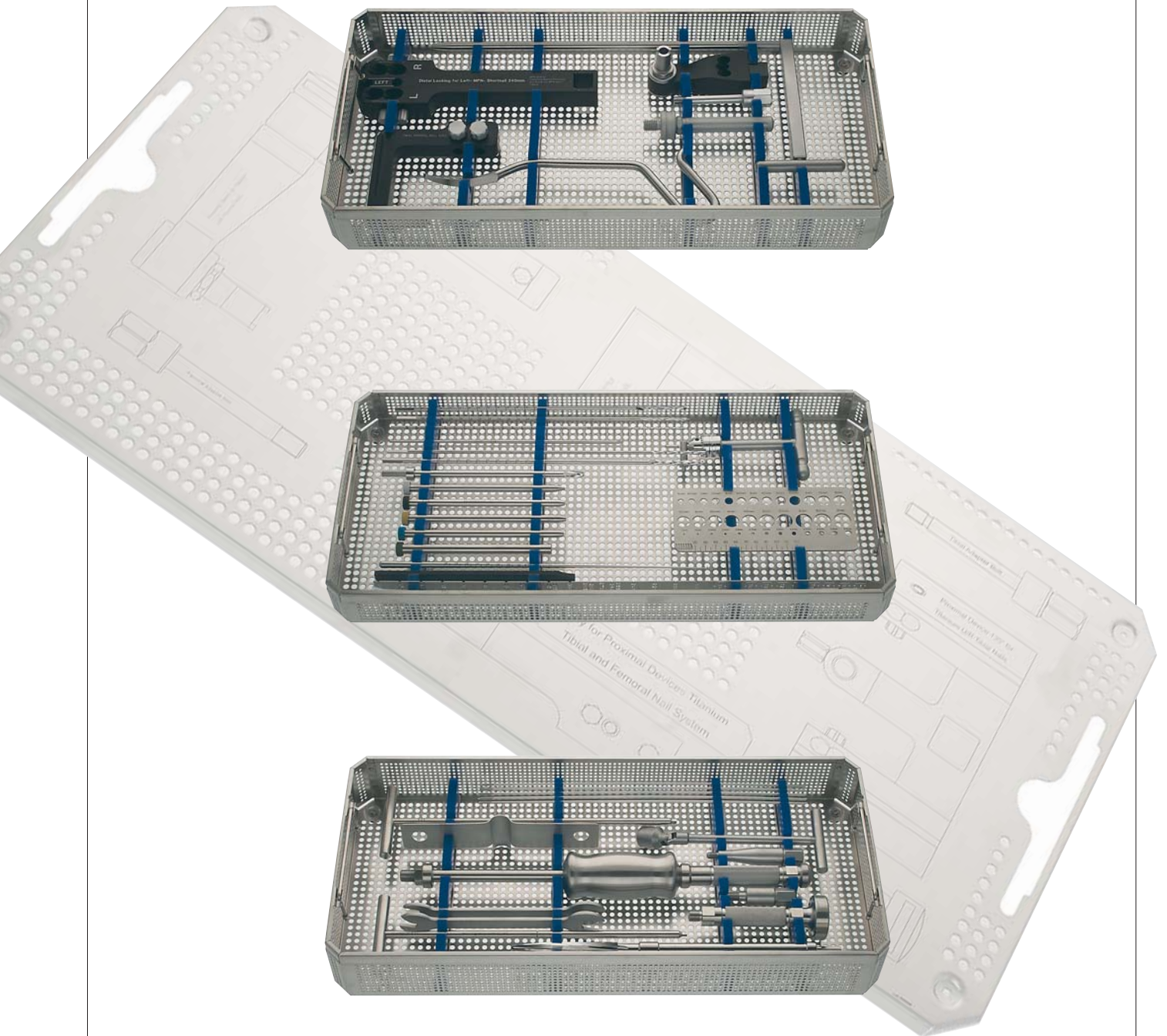

Listing: Basic Instruments for 95-970.00
Liste: Basis Instrumente für 95-970.00

95-948.00	Universal Socket Wrench	Kardanschlüssel SW 17
95-646.02	Hex Driver (non cannulated) for 4.5 mm and 5.0 mm V - Screws	Hexagonaler Schraubendreher (nicht kannuliert) für 4,5 mm und 5,0 mm V - Schrauben
95-646.01	Hex Driver (cannulated) for 6.4 mm Solid and Cannulated Locking Bolts	Hexagonaler Schraubendreher (kannuliert) für 6,4 mm, - kannulierte 6,4 mm V - Bolzen
95-653.00	Medullary Exchange Tube	Wechsel Tube
95-654.00	Internal Fracture Alignment Device	Internes Ausrichtungsinstrument
95-633.00	Depth Gauge	Tiefenmesser
95-625.35	Twist Drill, ø 3.5 mm, Length 305 mm	Kalibrierter Bohrer, ø 3,5 mm, Länge 305 mm
95-625.40	Twist Drill, ø 4.0 mm, Length 305 mm	Kalibrierter Bohrer, ø 4,0 mm, Länge 305 mm
95-625.48	Twist Drill, ø 4.8 mm, Length 305 mm	Kalibrierter Bohrer, ø 4,8 mm, Länge 305 mm
95-628.00	Trocar ø 4.0 mm x 240 mm	Trokar ø 4,0 mm x 240 mm
95-630.00	Guide Rod for Cannulated Screws, ø 1.8 mm x 350 mm (10 pieces)	Bohrdraht für kannulierte Schrauben, ø 1,8 mm x 350 mm (10 Stück)
95-647.00	Open End Wrench SW 17 / 14 (2 pieces)	Gabelschlüssel SW 17 / 14 (2 Stück)
95-631.00	Reamer / Nail and Screw Template	Fräser / Bohrer / Nagel und Schraubensablone
95-932.00	Nail Length Gauge	Nagel - Längenmeßlehre
95-637.00	Supine Driver	Einschläger
95-172.02	Handle with Jakobs Chuck	Handstück mit Jakobsfutter
95-660.00	Tibial Proximal Device	Proximal Tibia - Zielgerät
95-633.00	Skin Protector	Hautschutz
95-942.10	Tapered Reamer, cannulated ø 15.5 mm for Femoral MFN. (DNS.) - Nails	Kannulierter Formfräser ø 15,5 mm für Femur MFN. (DNS.) - Nägel
95-640.00	Curved Awl	Gebogene Öffnungssahle
95-642.00	Tapered Reamer, cannulated ø 13.5 mm for Femoral / DNS. - U/R Nails	Kannulierter Formfräser ø 13,5 mm für Femur / DNS.- U/R Nägel
95-645.01	Green Drill Sleeve ø 8.0 mm	Bohrhülse Grün ø 8,0 mm
95-645.03	Silver Drill Sleeve ø 2.1 mm	Bohrhülse Silber ø 2,1 mm
95-645.06	Blue Drill Sleeve ø 4.8 mm	Bohrhülse Blau ø 4,8 mm
95-645.04	Gold Drill Sleeve ø 4.0 mm	Bohrhülse Gold ø 4,0 mm
95-645.05	Black Drill Sleeve ø 3.5 mm	Bohrhülse Schwarz ø 3,5 mm
95-634.00	Slide Hammer	Gleithammer
95-652.00	Tibial Extractor Bolt	Tibia Extraktionsschraube
95-652.50	Femoral and DNS. / MFN. - Femoral Nail, Extractor Bolt	Femur und DNS. / MFN. - Femur Nagel, Extraktionsschraube
95-638.00	Length Gauge DNS. / MFN.	Längenmesslehre DNS. / MFN.
95-809.00	Nail Adapter Bolt for Drill Guide	Nageladaptionsschraube für Zielgerät
95-810.01	Universal Proximal Device for Femoral and DNS. / MFN. - Femoral Nails	Universales Proximalzielgerät für Femur und DNS. / MFN. - Femur Nägel
95-810.10	Twist Drill Cannulated ø 4.0 mm, Length 305 mm	Kannulierter Bohrer ø 4,0 mm, Länge 305 mm
95-810.15	Twist Drill Cannulated ø 4.8 mm, Length 305 mm	Kannulierter Bohrer ø 4,8 mm, Length 305 mm
95-810.25	DNS. / MFN. - Reamer ø 6.4 mm - Proximal	DNS. / MFN. - Fräser ø 6,4 mm - Proximal



95-970.50 Container for 95-970.00
Sterilbehälter für 95-970.00

(recommended)



95-648.00 Universal Socket Wrench
Kardanschlüssel SW 17

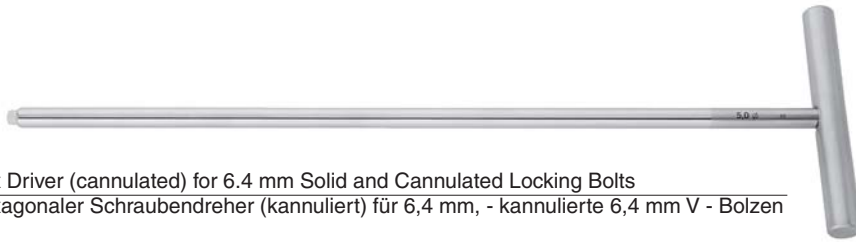

95-646.01 Hex Driver (cannulated) for 6.4 mm Solid and Cannulated Locking Bolts
Hexagonaler Schraubendreher (kannuliert) für 6,4 mm, - kannulierte 6,4 mm V - Bolzen

95-646.02 Hex Driver (non cannulated) for 4.5 mm and 5.0 mm V - Screws
Hexagonaler Schraubendreher (nicht kannuliert) für 4,5 mm und 5,0 mm V - Schrauben

95-646.03 Hex Driver (cannulated) for 5.0 mm cannulated Locking Screws (recommended)
Hexagonaler Schraubendreher (kannuliert) für kannulierte 5,0 mm Schrauben (empfohlen)



95-653.00 Medullary Exchange Tube
Wechsel Tube

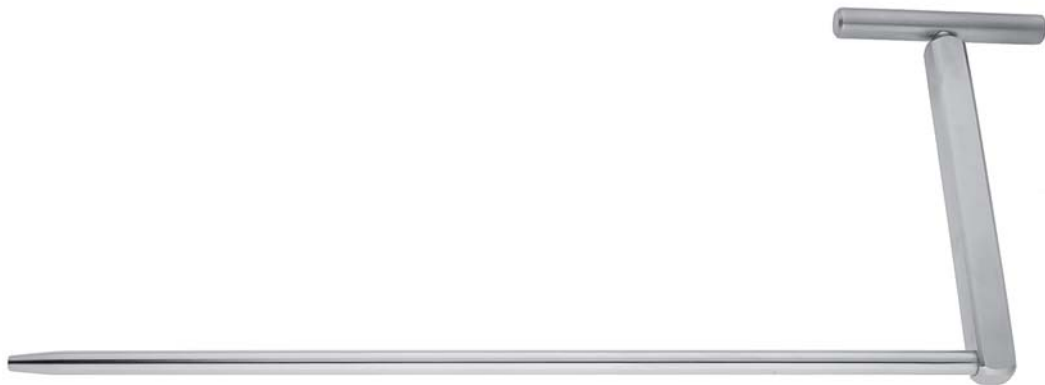

95-654.00 Internal Fracture Alignment Device
Internes Ausrichtungsinstrument



95-633.00 Depth Gauge
Tiefenmesser



Drill Bits Cannulated hole \varnothing 2.1 mm Length 150 mm (recommended)
Kannulierter Bohrer Bohrung \varnothing 2,1 mm Länge 150 mm (empfohlen)

Cat. No.	\varnothing mm
95-625.35	3,5
95-625.40	4,0
95-625.48	4,8



Drill Bits Length 150 mm (recommended)
Bohrer Länge 150 mm (empfohlen)

Cat. No.	\varnothing mm
95-626.27	2,7
95-626.35	3,5
95-626.40	4,0
95-626.48	4,8



Twist Drills Length 305 mm
Kalibrierter Bohrer Länge 305 mm

Cat. No.	\varnothing mm
95-627.35	3,5
95-627.40	4,0
95-627.48	4,8



95-628.00 Trocar \varnothing 4.0 mm x 240 mm
Trokar \varnothing 4,0 mm x 240 mm



95-629.00 Tip Threaded Guide Pin \varnothing 3.2 mm x 305 mm (recommended)
Bohrdraht mit Gewinde \varnothing 3,2 mm x 305 mm (empfohlen)



95-630.00 Guide Rod for Cannulated Screws, \varnothing 1,8 mm x 350 mm
Bohrdraht für kannulierte Schrauben, \varnothing 1,8 mm x 350 mm

Guide Rods with Spade Tip are only for Flexible Medullary Reamers
Führungsdrähte

95-651.01 Guide Rod for IM Nail, \varnothing 2,4 mm, Length 900 mm
 Führungsdraht \varnothing 2,4 mm, Länge 900 mm

95-651.02 Guide Rod for IM Nail, \varnothing 3,0 mm, Length 900 mm
 Führungsdraht \varnothing 3,0 mm, Länge 900 mm

95-651.03 Guide Rod for Reamer, \varnothing 2,0 mm, Length 900 mm with \varnothing 3,0 mm Spade Tip
 Führungsdraht mit Olive \varnothing 2,0 mm, Länge 900 mm

95-651.04 Guide Rod for Reamer, \varnothing 3,0 mm, Length 900 mm with \varnothing 4,0 mm Spade Tip
 Führungsdraht mit Olive \varnothing 3,0 mm, Länge 900 mm

95-651.05 Guide Rod, \varnothing 3,0 mm, Length 900 mm with curved Tip
 Führungsdraht gebogen \varnothing 3,0 mm, Länge 900 mm

95-651.06 Guide Rod, \varnothing 2,4 mm, Length 900 mm with curved Tip
 Führungsdraht gebogen \varnothing 2,4 mm, Länge 900 mm



95-647.00 Open End Wrench SW 17 / 14
 Gabelschlüssel SW 17 / 14

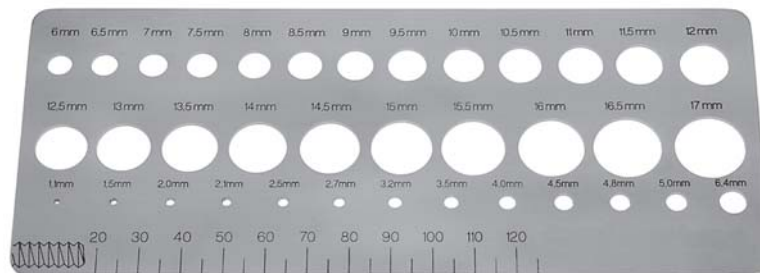

95-631.00 Reamer / Nail and Screw Template
 Fräser- / Bohrer- / Nagel- und Schraubenschablone



95-632.00 Nail Length Gauge
Nagel - Längenmeßlehre



95-637.00 Supine Driver
Einschläger



95-172.02 Handle with Jakobs Chuck
Handstück mit Jakobsfutter



95-639.00 Skin Protector
Hautschutz

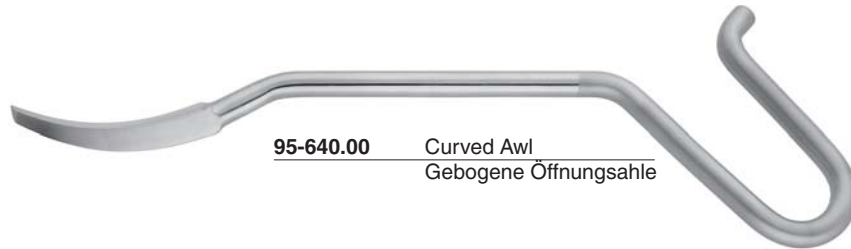

95-640.00 Curved Awl
Gebogene Öffnungssahle

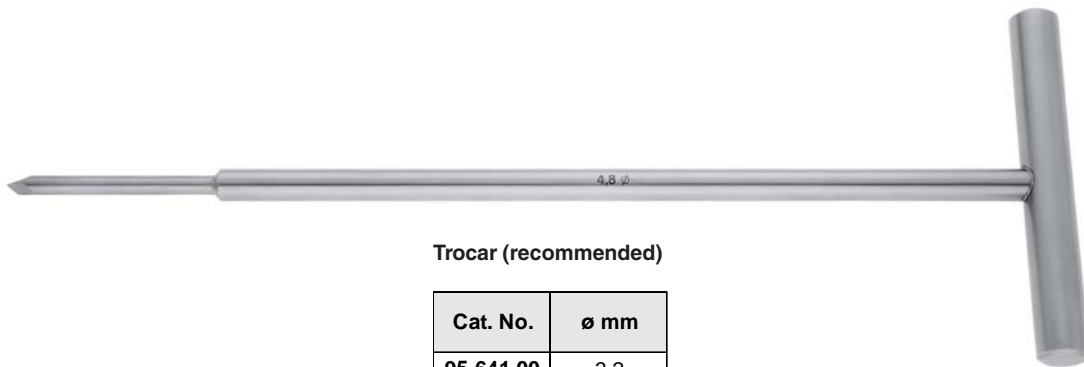

Trocar (recommended)

Cat. No.	ø mm
95-641.00	3,2
95-641.40	4,0
95-641.48	4,8
95-641.80	8,0



95-642.00 Tapered Reamer, cannulated ø 13.5 mm for Femoral MFN. / DNS. - U/R Nails
Kannulierter Formfräser ø 13,5 mm für Femur MFN. / DNS.- U/R Nägel



95-630.00 Guide Rod for Cannulated Screws, ø 1,8 mm x 350 mm
Bohrdraht für kannulierte Schrauben, ø 1,8 mm x 350 mm



95-809.00 Nail Adapter Bolt for Drill Guide MFN. / DNS.
Nageladaptionsschraube für Zielgerät MFN. / DNS.



95-645.01 Green Drill Sleeve \varnothing 8.0 mm
Bohrhülse Grün \varnothing 8,0 mm



95-645.03 Silver Drill Sleeve \varnothing 2.1 mm
Bohrhülse Silber \varnothing 2,1 mm



95-645.05 Black Drill Sleeve \varnothing 3.5 mm
Bohrhülse Schwarz \varnothing 3,5 mm



95-645.04 Gold Drill Sleeve \varnothing 4.0 mm
Bohrhülse Gold \varnothing 4,0 mm



95-645.06 Blue Drill Sleeve \varnothing 4.8 mm
Bohrhülse Blau \varnothing 4,8 mm



95-634.00 Slide Hammer
Gleithammer



95-652.00 Tibial Extractor Bolt
Tibia Extraktionsschraube



95-652.50 Femoral and DNS. - Femoral Nail, Extractor Bolt
Femur und DNS.-Femur Nagel, Extraktionsschraube

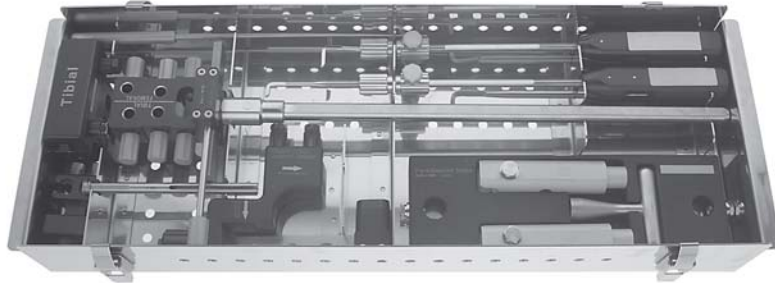

95-663.60 Sterilizing Container for Distal Device Equipment (empty)
 Sterilisationsbehälter für Distales Zielgerät - System (nicht gefüllt)

95-663.60 Sterilizing Container for Distal Device Equipment (empty)

To include:	95-662.00	Distal Targeting Device
	95-659.05	Outrigger
	95-659.10	Wrench SW 14
	95-663.00	Pre - Adjustment Device
	95-659.01	Tibial Adapter Block
	95-659.02	MFN. / DNS. / Femoral Adapter Block
	95-659.15	Fixation Hook - 20 mm
	95-659.16	Fixation Hook - 15 mm
	95-659.20	Hook Impactor Sleeve
	95-659.25	Hook Awl for 95-659.15 - 20 mm
	95-659.26	Hook Awl for 95-659.16 - 15 mm
	95-659.30	Nail Feeler

95-663.60 Sterilisationsbehälter für Distales Zielgerät - System (nicht gefüllt)

Zur Aufnahme von:	95-662.00	Distales Zielgerät
	95-659.05	Haken - Arm
	95-659.10	Schlüssel SW 14
	95-663.00	Voreinstellgerät
	95-659.01	Tibia - Adapter Block
	95-659.02	MFN. / DNS. / Femur Adapter Block
	95-659.15	Fixationshaken - 20 mm
	95-659.16	Fixationshaken - 15 mm
	95-659.20	Hakenführungshülse zur Hakeneinführung
	95-659.25	Hakenahle für 95-659.15 - 20 mm
	95-659.26	Hakenahle für 95-659.16 - 15 mm
	95-659.30	Nagelfühler - Instrument



95-662.00 Distal Targeting Device
Distales Zielgerät



95-663.00 Pre - Adjustment Device
Voreinstellgerät



95-659.01 Tibial Adapter Block
Tibia Adapter Block



95-659.02 Femoral MFN. / DNS. - Adapter
Femur MFN. / DNS. - Adapter



95-659.05 Outrigger
Haken - Arm



95-659.10 Wrench SW 14
Schlüssel SW 14

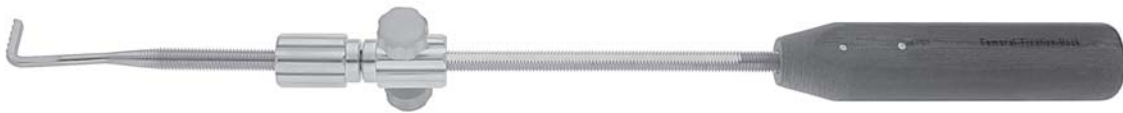

95-659.15 Fixation Hook - 20 mm
Fixationshaken - 20 mm

95-659.16 Fixation Hook - 15 mm
Fixationshaken - 15 mm



95-659.20 Hook Impactor Sleeve
Hakenführungshülse zur Hakeneinführung



95-659.25 Hook Awl for 95-659.15 - 20 mm
Hakenahle für 95-659.15 - 20 mm

95-659.26 Hook Awl for 95-659.16 - 15 mm
Hakenahle für 95-659.16 - 15 mm



95-659.30 Nail Feeler
Nagelfühler Instrument

ORIHOMEDICAL

G m b H · I M P L A N T S

Hauptstrasse 5 · D-78589 Dürbheim
Tel.: 0 74 24 / 94 03-40 · Fax: 0 74 24 / 94 03-43
www.orthomedical.de · email: mail@orthomedical.de
